



Department of Electrical Engineering
and Computer Science
University of California
Berkeley, California 94720

Ptolemy: A Framework for Simulating and Prototyping Heterogeneous Systems

Joseph Buck
Soonhoi Ha
Edward A. Lee
David G. Messerschmitt

1.0 ABSTRACT

Ptolemy is an environment for simulation and prototyping of heterogeneous systems. It uses modern object-oriented software technology (C++) to model each subsystem in a natural and efficient manner, and to integrate these subsystems into a whole. Ptolemy encompasses practically all aspects of designing signal processing and communications systems, ranging from algorithms and communication strategies, simulation, hardware and software design, parallel computing, and generating real-time prototypes. To accommodate this breadth, Ptolemy must support a plethora of widely-differing design styles. The core of Ptolemy is a set of object-oriented class definitions that makes few assumptions about the system to be modeled; rather, standard interfaces are provided for generic objects and more specialized, application-specific objects are derived from these. A basic abstraction in Ptolemy is the Domain, which realizes a computational model appropriate for a particular type of subsystem. Current examples of domains include synchronous and dynamic dataflow, discrete-event, and others appropriate for control software and embedded microcontrollers. Domains can be mixed as appropriate to realize an overall system simulation. Some current applications of Ptolemy include networking and transport, call-processing and signaling software, embedded microcontrollers, signal processing (including implementation in real-time real-time), scheduling of parallel digital signal processors, board-level hardware timing simulation, and combinations of these.

Key words: Heterogeneity, mixed-mode, simulation, prototyping, object-oriented programming

Invited paper in the *International Journal of Computer Simulation* special issue on "Simulation Software Development".

2.0 INTRODUCTION

Ptolemy is a simulation and rapid prototyping framework for heterogeneous systems. It is ideal for applications in which heterogeneity is a key characteristic. such as:

- Design of multimedia networks;
- Real-time embedded software;
- Hardware/Software codesign;
- Control and call-processing in telecommunications networks;
- Rapid prototyping of new telecommunications services;
- Mixed-mode hardware simulation;
- Mapping applications onto heterogeneous multiprocessor systems; and
- Mixed signal processing and real-time control.

For example, in the design of multimedia networks, we are interested in studying the interaction between transport, compression or compositing signal processing, and control software in voice or video services over cell-relay networks. In telecommunication systems we are interested in studying the interaction between call-processing software and hardware switch elements. To develop new telecommunication services, we must jointly design control software, signal processing, transport, and hardware elements.

In hardware design we are interested in modeling components with varying detail, such as behavioral, logic, timing, and circuit. In system-level design, we may wish to jointly design the communications infrastructure and the processing elements. We may also wish to synthesize (in combination) microcode for specialized processors, C code for generic processors, routing tables for field-programmable gate arrays, and custom VLSI. We may wish to automate mappings onto parallel processors by mixing specialized schedulers, such as those that target systolic arrays [11], or those that address only applications with predictable control flow [28].

Simulation and system specification environments that support heterogeneity have been developed before. For example, mixed-mode circuit simulation is now the standard way to deal with complex VLSI circuits. At a higher level, the STATEMATE system by i-Logix [11] combines activity charts, which describe dataflow, with statecharts [10], which describe control. A very different flavor of heterogeneous system is a *coordination language*, like Granular Lucid [14], which combines standard procedural languages with an “indexical model” (a sort of multidimensional declarative model). Another example of a coordination language is Linda [5]. All of these heterogeneous systems, however, assume a small number of pre-defined sets of semantics that prove central to the system design. We avoid pre-defining the semantics we can accommodate.

An alternative to heterogeneity is generality. For example, VHDL is a relatively large language with considerable semantic richness, so that it can accommodate different styles of system description [13]. Petri nets can model parallelism and timing relationships in a huge variety of applications [26]. In addition, specialized models can be combined into more general models with unified semantics. For example, dataflow and discrete-event semantics have been combined for hardware design [33] and graphical programming [31]. However, such generality has a price. Analysis of systems using such general descriptions is difficult, and efficient compilers are difficult to implement. In the case of VHDL, for example, all effective VLSI synthesis tools restrict their domain to a subset of the language. Unfortunately, each tool chooses a different subset, nullifying the benefits of a standardized language. Similarly, effective parallel schedulers restrict their domain to special cases of Petri nets. Furthermore, the complexity and diversity in system-level design is only going to increase. Although any Turing-equivalent model can, in principle, handle any computational design, clearly there are benefits from specializing the specification language. We believe we cannot anticipate all the languages and models of computation that will prove effective. Our approach, therefore, is to embrace heterogeneity by allowing the user to mix different subsystem modeling descriptions, without restricting those descriptions.

The key innovation in Ptolemy is a *non-dogmatic* kernel that does not presuppose a dataflow or functional model, finite-state machines, statecharts, communicating sequential processes, or Petri nets. Rather, Ptolemy can accommodate all of these. Most importantly, the objective is to

combine descriptions so that complex systems can be designed *heterogeneously*. Ptolemy can be viewed as a coordination language, but since it is not a language in any conventional sense, we prefer to describe it as a *coordination framework*.

Of course, our limited resources have made it impossible to explore combinations of all the models of computation described above. Hence, we cannot yet claim to have fully proven our concept. Furthermore, our experience indicates that combining highly dissimilar models of computation is not trivial. Our hope is that by providing an open architecture with well-defined interfaces, a community of users with very different design approaches can test our ideas.

A typical large system is structured as shown in Figure 1. It consists of heterogenous subsystems (some implemented in hardware, some in software) together with a software control subsystem and a communications infrastructure. Ptolemy models such systems well. Consider for example a portion of a multimedia connection through a broadband packet network as shown in Figure 2. In this heterogenous system, the video compression (signal processing), transport (networking) and control (software) subsystems are most conveniently modeled in much different ways, and yet there is a desire to study the interaction of these subsystems. Another example that requires similar heterogeneity is shown in Figure 3. A computing resource (perhaps a futuristic workstation) consists of a familiar UNIX¹ processor, a separate processor running a specialized real-time operating system, a third processor for hard-real-time signal processing (running no operating system), and programmable hardware for truly intensive tasks (such as protocol implementations and I/O interfaces to custom devices). A unified environment for programming such a

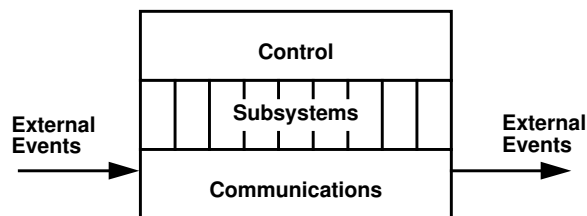

Figure 1. Typical structure of a large system.

1. UNIX is a trademark of AT&T.

heterogeneous combination of computing resources must support the different design styles that would be used for each resource.

Ptolemy uses object-oriented software principles to achieve the following goals:

- *Agility*: Support distinct computational models, so that each subsystem can be simulated and prototyped in a manner that is appropriate and natural to that subsystem.
- *Heterogeneity*: Allow distinct computational models to coexist seamlessly for the purpose of studying interactions among subsystems.

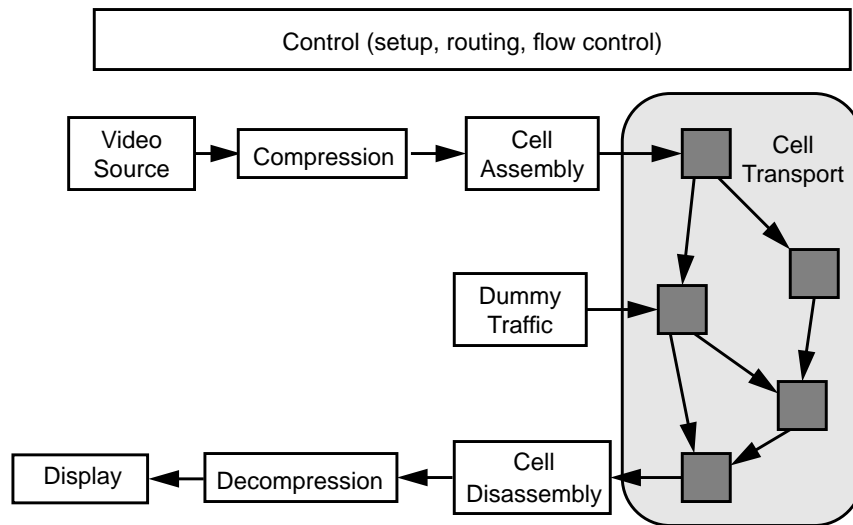

Figure 2. A packet video connection through an ATM broadband packet network.

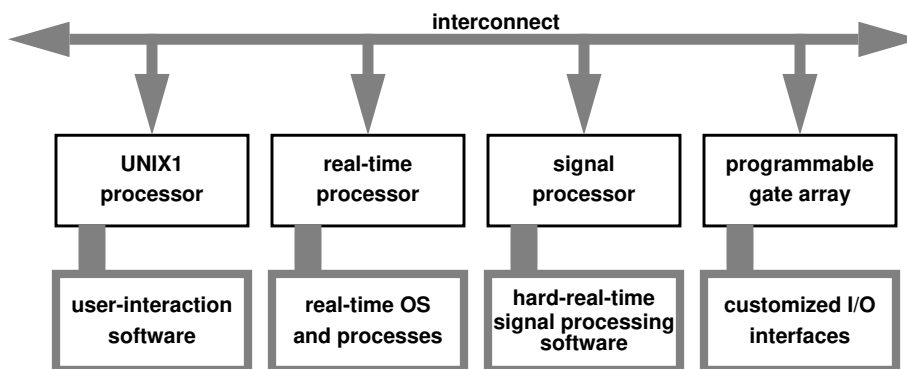

Figure 3. A heterogeneous hardware and software platform.

- *Extensibility*: Support seamless integration of new computational models and allow them to interoperate with existing models with no changes to Ptolemy or to existing models.
- *Friendliness*: Use a modern graphical interface with a hierarchical block-diagram style of representation.

In Figure 4, we show a simplified but complete example that combines signal processing with network simulation, and hence demonstrates the heterogeneity in Ptolemy. In this example, the lower block diagram models a highly simplified packet-switched communication network, in which packets randomly traverse one of two paths. The upper path has no delay, while the lower

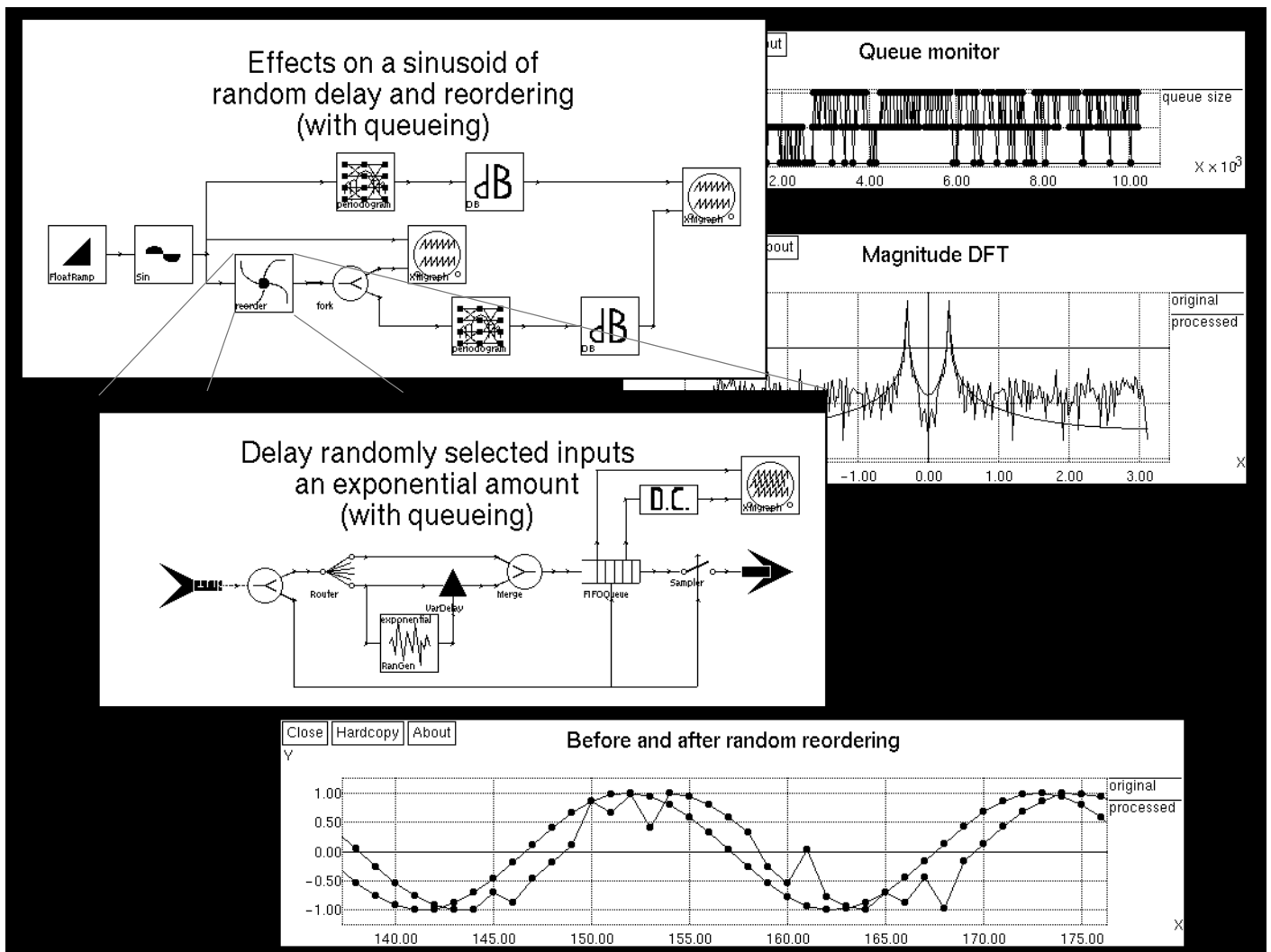

Figure 4. Simulation of the effect of a very simple model of a packet switched network on a sinusoid, illustrating a mixture of signal processing and networking in one simulation.

path has random delay. At the receiving end, a queue stores incoming packets until they are needed by the destination. In the upper left window is a highly simplified signal processing system making use of the network. A sinusoid is generated and packetized, one sample per packet, and launched into the network. At the receiving end, packets are used to reconstruct the sinusoid at the same sample rate. The packets are used in the order of arrival, so the samples of the sinusoid get randomly scrambled, as shown in the lower plot. Real-time constraints are modeled, so if packets do not arrive in time, earlier packets are re-used. The effect on the spectrum is shown in the middle plot, and the size of the queue is monitored in the upper plot.

In practical applications with similar structure, both the network model and the signal processing will be much more elaborate. For instance, Ptolemy is currently being used to evaluate video encoding algorithms for transmission over ATM (asynchronous transfer mode) networks.

3.0 Internal Structure of Ptolemy

Ptolemy relies heavily on the methodology of object-oriented programming (OOP). In this section we describe the essentials of the class hierarchy that defines the Ptolemy kernel.

3.1 Blocks and Particles

The basic unit of modularity in Ptolemy is the Block¹, illustrated in Figure 5. A Block contains a module of code (the “go()” method) that is invoked at run-time, typically examining data present at its input Portholes and generating data on its output Portholes. Depending on the model of computation, however, the functionality of the go() method can be very different; it may spawn processes, for example, or synthesize assembly code for a target processor. Its invocation is directed by a Scheduler (another modular object). A Scheduler determines the operational semantics of a network of Blocks. Blocks and Schedulers can be designed by end users, lending generality while encouraging modularity. The hope is that Blocks will be well documented and stored in standard libraries, rendering them modular, reusable software components.

1. When we capitalize a modular element, then it represents an object type. In object-oriented programming, objects encapsulate both data, the state of the object, and functions operating on that state, called methods.

PortHoles provide the standard interface through which Blocks communicate. Some of the key PortHole methods are shown in Figure 5, such as “grabData()” and “sendData(),” which can be invoked within the “go” method. A Scheduler interacts with Blocks through a standard set of polymorphic¹ methods such as “start()” to initialize the state of the Block, “go()” for runtime execution, and “wrapup()” to conclude the execution. Ptolemy also defines methods for building and editing a network of Blocks, such as the “clone()” for creating another instance of the Block.

The user-interface view of the system is an interconnected block diagram. Blocks can communicate using streams of Particles. A Particle is a base type for all messages. Simple examples of classes derived from Particle are FloatSample, FixSample, and ComplexSample, all used in stream-oriented domains such as dataflow and discrete-event. A user can derive other message types from the Particle, such as one-dimensional and two-dimensional data structures, data packets, and control tokens, invisibly to Ptolemy. This use of OOP inheritance² allows Ptolemy to deal transparently with many system modeling problems, such as speech, video, and packet data net-

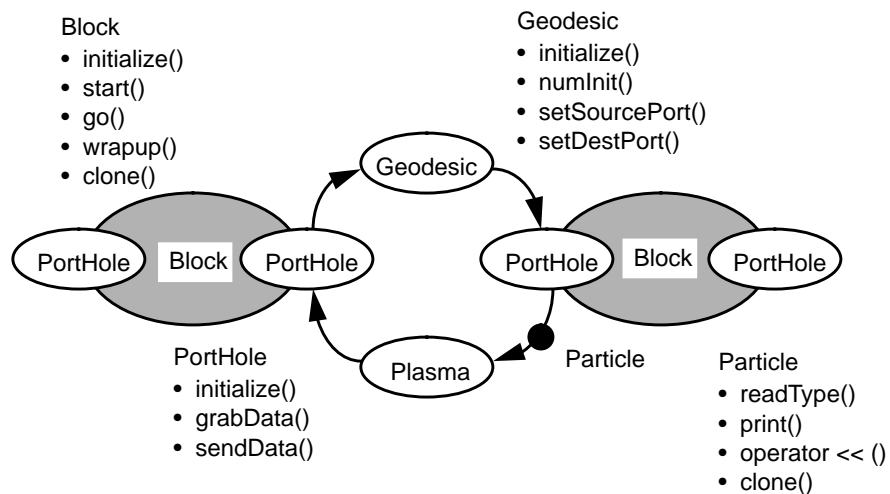

Figure 5. Block objects in Ptolemy send and receive data encapsulated in Particles to the outside world through Portholes. Buffering and transport is handled by the Geodesic and garbage collection by the Plasma.

1. Polymorphic methods is a term from object-oriented programming that refers to methods applied uniformly across a group of similar objects. Each object substitutes the correct functionality for that object. Polymorphism is a powerful abstraction tool used extensively in Ptolemy.

2. In object-oriented programming, inheritance refers to the derivation of a new, more functional and specialized, object type by including an existing inherited type and adding or replacing states and methods.

works. The Geodesic class establishes the connection between PortHoles. The Plasma class manages the reclamation of the used Particles so that elaborate garbage collection is not required.

Type conversions are performed automatically for the basic types provided with Ptolemy, so that a block that produces integers can be connected with a block that expects real values, for example. Type conversions may also be defined for user-defined Particles. Blocks can also be defined to accept ANYTYPE; such blocks can route or duplicate Particles without regard to their types. These Blocks manipulate Particles using only methods defined in the base class.

3.2 Stars, Galaxies, and the Universe

A conventional way to manage the complexity of a large system is to introduce a hierarchy in the description, as shown in Figure 6. The lowest level (atomic) objects in Ptolemy are of type Star, derived from Block. A Star that performs some computation belongs to a *domain*, as explained below. The Stars in domain named “XXX” are of type XXXStar, derived from Star. A Galaxy, also derived from Block, contains other Blocks internally. A Galaxy may contain internally both Galaxies and Stars. A Galaxy may exist only as a descriptive tool, in that a Scheduler may ignore the hierarchy, viewing the entire network of blocks as flat. All our dataflow schedulers do this to maximize the visible concurrency, getting the effect of non-strict function invocation. Alternatively, a Scheduler may make use of the hierarchy to minimize scheduling complexity or

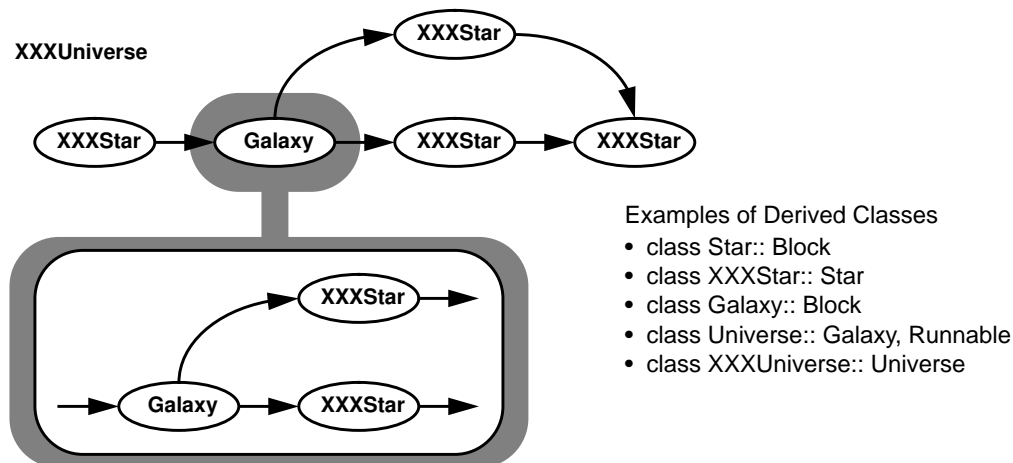

Figure 6. A complete Ptolemy application (a Universe) consists of a network of Blocks. Blocks may be Stars (atomic) or Galaxies (composite). The “XXX” prefix symbolizes a particular domain (or model of computation).

to structure synthesized code in a readable way. A Universe, which contains a complete Ptolemy application, is a type of Galaxy. It is multiply derived from Galaxy and class Runnable. The latter class contains methods for execution of simulation or synthesis of code.

3.3 Targets and Schedulers

A Target, also derived from Block, controls the execution of an application. In a simulation-oriented application, it will typically invoke a Scheduler to manage the order in which Star methods are invoked. For a synthesis-oriented application, it can do much more. It can, for example, synthesize assembly code for a programmable DSP, invoke an assembler, download the code into attached hardware, execute the code, and manage the communication between the host and the attached processor. It can also partition a heterogeneous application among subtargets (by invoking a Scheduler) and then invoke Schedulers in the subtargets to handle the detailed synthesis. This is illustrated in Figure 7, where some of the representative methods and members of the Target class are shown. Targets can have parameters that may be set by the end user.

The top-level Universe object contains a pointer to a dynamically allocated Target. For most simulation applications, the default Target simply passes its messages on to a Scheduler appropriate for the model of computation being used.

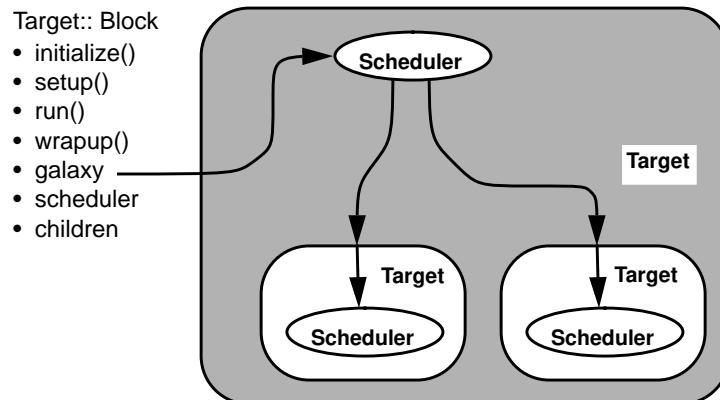

Figure 7. A Target, derived from Block, manages a simulation or synthesis execution. It can invoke its own Scheduler on a Galaxy, which can in turn invoke Schedulers in sub-Targets.

3.4 Heterogeneity: The Domain

A Domain in Ptolemy consists of a set of Blocks, Targets, and associated Schedulers that conform to a common computational model. By “computational model” we mean the operational semantics governing how Blocks interact with one another. A Scheduler will exploit knowledge of these semantics to order the execution of the Blocks. Two domains are illustrated in Figure 8. Stars and Targets are shown within each domain. The inner Domain (designated YYY) in Figure 8 is an illustration of a *sub-Domain*, which implements a more specialized model of computation than the outer Domain (XXX). Hence all its Stars and Targets can also be used with the outer Domain. Schedulers can be associated with more than one Domain, but a Scheduler for a sub-Domain is not necessarily valid within the outer Domain. The Domain and the mechanism for co-existence of Domains are the primary abstractions that distinguished Ptolemy from otherwise comparable systems.

Some examples of Domains that are currently available or being designed are listed below:

- Dynamic dataflow (DDF) is a data-driven model of computation originally proposed by Dennis [7]. Although frequently applied to design parallel architectures, it is also suitable as a programming model [6], and is particularly well-suited to signal processing that includes asynchronous operations. An equivalent model is embodied in the predecessor system Blossim

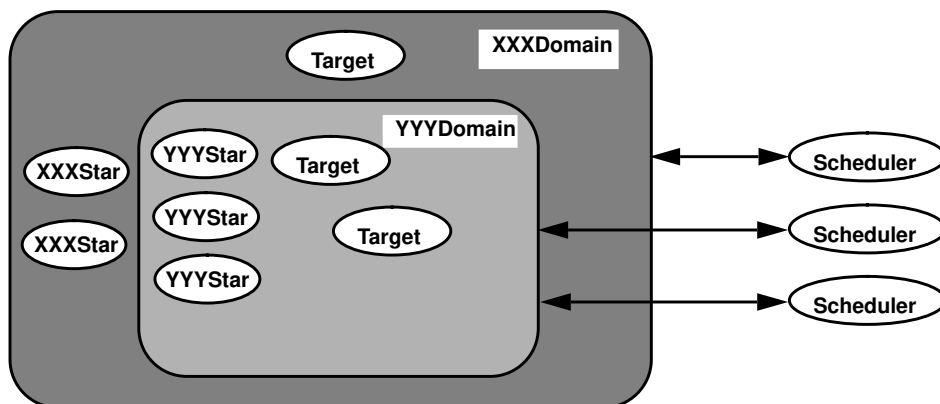

Figure 8. A Domain (XXX) consists of a set of Stars, Targets and Schedulers that support a particular model of computation. A sub-Domain (YYY) may support a more specialized model of computation.

[23][24]. In DDF, Stars are enabled by data at their input PortHoles. That data may or may not be consumed by the Star when it fires, and the Star may or may not produce data on its outputs. More than one Star may be fired at one time if the Target supports this parallelism. We have used this domain to experiment with static scheduling of programs with run-time dynamics [9]. The DDF Domain does not attempt to model the relative timing relationship of Block invocations.

- Synchronous dataflow (SDF) [17][18] is a sub-Domain of DDF. SDF Stars consume and generate a static and known number of data tokens on each invocation. Since this is clearly a special case of DDF, any Star or Target that works under the SDF model will also work under the DDF model. However, an SDF Scheduler can take advantage of this static information to construct a schedule that can be used repeatedly. Such a Scheduler will not always work with DDF Stars. SDF is an appropriate model for multirate signal processing systems with rationally-related sampling rates throughout [3], and is the model used exclusively in Ptolemy's predecessor system Gabriel [19][2]. The advantages of SDF are ease of programming (since the availability of data tokens is static and doesn't need to be checked), a greater degree of setup-time syntax checking (since sample-rate inconsistencies are easily detected by the system), run-time efficiency (since the ordering of Block invocation is statically determined at setup-time rather dynamically at run-time), and automatic parallel scheduling [29][30][20].
- Boolean dataflow (BDF) is a model intermediate between SDF and DDF, in which a limited but practically important set of asynchronous operations (analogous to the if-then-else or case statement in C) is supported, with many if not most of the advantages of SDF [4][21]. This is an experimental domain currently being developed, and will be described in detail in a future paper.
- Discrete event (DE) is a model in which only changes in system state (called events) are modeled. This is an asynchronous model like DDF, but unlike DDF incorporates the concept of global time in the system and orders Block invocations properly in time. A completely general simulation system could be developed in the DE domain, at the expense of run-time efficiency and ease and naturalness of programming for many applications like signal processing.

- Message queue (MQ) is a model similar to DDF but with many more capabilities for dynamically creating and destroying Blocks. The MQ domain is another experimental domain under development targeted at software control applications, such as telephone switching call-processing software. An interesting distinction between MQ and many other domains is that graphical representations of the applications is probably neither reasonable nor appropriate.

In addition to these domains, it is possible to create domains out of previously-existing simulation systems, as has been demonstrated with the Capsim [8] domain (incorporating the Capsim signal processing system that is based on Blosim) and the Thor domain (incorporating the Thor hardware timing simulator [32]). We are also beginning to design a domain with finite-state-machine semantics.

The Domain class by itself makes Ptolemy agile (enabling modeling of different types of systems in a natural and efficient manner), but we need to be able to mix those descriptions at the system level). To accomplish this, Ptolemy allows different Domains to co-exist at different levels of the hierarchy. Within a domain, it is permissible to have Blocks containing foreign domains.

At the user interface, a foreign Domain appears to be a property of an internal Galaxy. However, at runtime it is a much different entity. A Galaxy does not have a Scheduler, and may be destroyed by flattening prior to runtime, while a foreign Domain does have a Scheduler and must not be flattened (its internal structure does not conform to the external model of computation). A given simulation can therefore contain a number of Schedulers, which must be coordinated.

3.5 The Wormhole

The manner in which different domains coexist is a critical design element of Ptolemy, and will therefore be further elaborated. As illustrated in Figure 9, the top-level view of a simulation consists of a Universe. This Universe has an associated domain, say XXX, and is a Block of type XXXUniverse (as shown in Figure 6). Internal to that Block is an XXXScheduler and a set of XXXStars. (The description of the Universe may also include Galaxies, but we omit them because they may be destroyed by flattening at runtime.) The introduction of a subsystem from a foreign domain, say domain YYY, is illustrated in Figure 10. This is accomplished by adding a Block which appears in the XXXDomain to be an XXXStar, but which is actually a much differ-

ent object internally because it contains a `YYYScheduler` and a set of `YYYStars`. We call this special object an `XXXWormhole`. One way to think of a Wormhole is as a Block which appears externally to be a Star (it obeys the operational semantics of the external domain and appears to be atomic to the external domain), but internally consists of an entire foreign Universe (Scheduler for a foreign domain and Stars for that domain). A Wormhole can be introduced into the `XXX` domain without any need for the `XXXScheduler` or other `XXXStars` to have knowledge of the semantics of domain `YYY`.

It should be clarified that although most existing domains in Ptolemy have the internal structure of Scheduler plus Stars, and are viewed at the user interface as an interconnected block

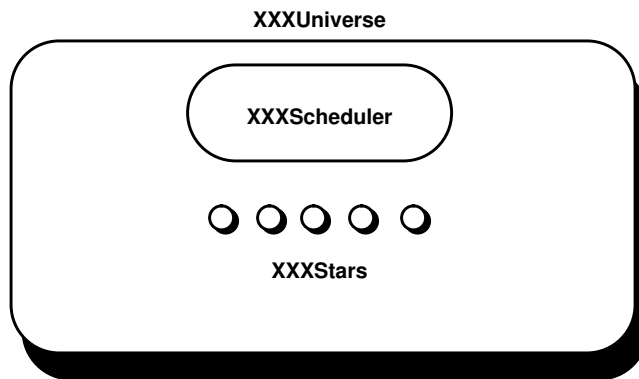

Figure 9. The Universe consists of a domain, and at runtime internal Stars which conform to the operational semantics of that domain's Scheduler.

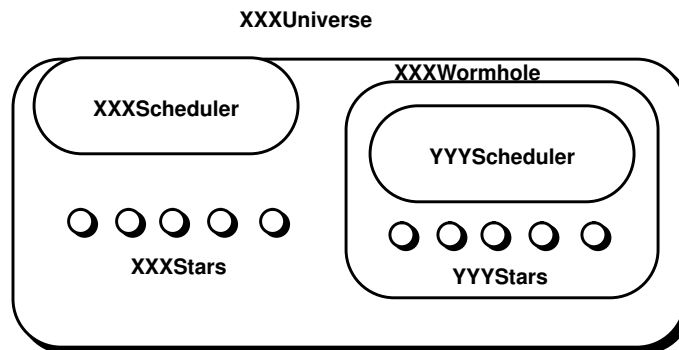

Figure 10. A new domain `YYY` is introduced by adding a Wormhole to the Universe.

diagram, this assumption is not built into Ptolemy. For purposes of interoperability, the only relevant view of a domain is the external interface of a Wormhole, and as long as it conforms to this external view it can have any internal structure whatsoever (just as a Star can have any internal code). For example, one could have domains where every object talks to every other object, and an interconnected block diagram makes no sense.

Wormhole objects also contain Target pointers; the Target by default may be the same as that for the parent Universe, but can be different. This facility can be used to execute part of a simulation on a workstation, while running another part of the simulation on a DSP board with code generated and downloaded by Ptolemy. In this case, the Target object in the Wormhole knows how to download and execute code on the DSP board.

3.6 The EventHorizon

The key to the support of heterogeneity in Ptolemy is the interoperability of different domains at runtime. In turn, the key to this interoperability is the interface between the internal structure of a Wormhole and its external environment. This interface is called the EventHorizon, and is illustrated in Figure 11. A “universal” EventHorizon is shared by all domains, so that each domain only needs to provide an interface to this EventHorizon. Hence we avoid having N^2 interfaces for N Domains.

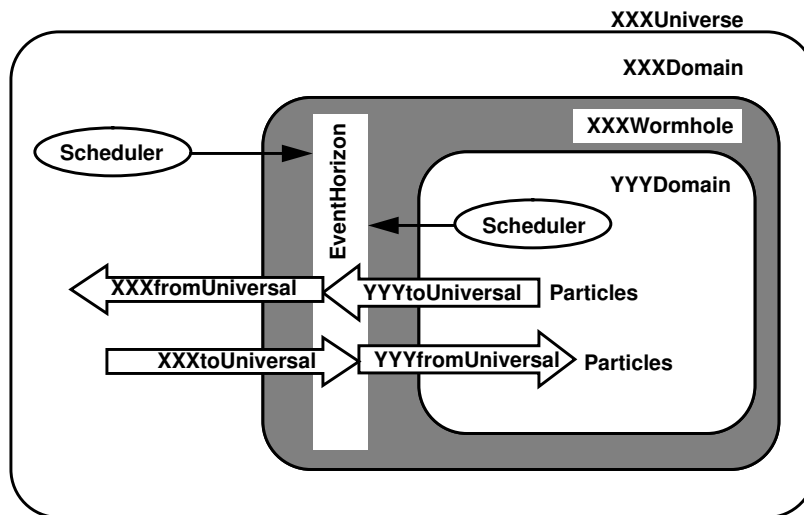

Figure 11. The universal EventHorizon provides an interface between the external and internal domains.

There are two types of interactions that occur at the EventHorizon as illustrated in Figure 11. The first is the conversion of Particles passing through the EventHorizon. For example, in some domains each Particle has an associated timestamp, and in other domains it does not, and hence there is the function of adding or deleting timestamps. The second interaction is the coordination of the Schedulers associated with the inside and outside domains. We will now describe both interactions in more detail.

3.6.1 Particle Conversion at the EventHorizon

Conversion between domain-specific representations of a Particle is accomplished by objects of class ToEventHorizon and FromEventHorizon, derived from EventHorizon, derived in turn from Porthole. For each specific Domain XXX, we define XXXtoUniversal and XXXfromUniversal. Since these are ultimately derived from class XXXPorthole, the XXXWormhole looks just like a XXXStar to XXX Domain. Particles are read from the XXXtoUniversal, transferred to the XXXfromUniversal, and sent to the inside XXX domain.

Some Domains have a notion of simulated time, and some do not. In order for the event horizon to work with both, when a Particle passes through the EventHorizon, it is always associated with a time stamp. A domain therefore need not know with which domain it is interacting. See the next subsection for the detailed discussion of timing relationship between domains.

EventHorizons may have other domain-specific responsibilities. One example can be found in SDFfromUniversal class. Suppose that the inner domain is SDF, the outer domain is DE, and the DEWormhole has more than one input. The DEWormhole is executed when any input has new data (an event). However, the inner SDF domain requires that all input data be available before execution. To resolve this conflict, the DEWormhole checks all SDFfromUniversal EventHorizons to see if they have enough data before turning control over to the inner SDFScheduler. Thus, the SDFfromUniversal synchronizes the input data, enforcing the model of computation assumed in the inside domain.

In some domains, Particle types are very restricted. For example, the Thor domain (used for timing simulations of hardware) allows only bits. Particle type conversion, however, is not the task of the EventHorizon. The Particle type of an EventHorizon is inherited from that of the Port-

Hole connected to it. Particle type conversion between two different types of Particles is performed automatically by the type conversion methods defined in the Particle class if both are built-in types such as integer, float, and complex. Otherwise, the type conversion should be managed explicitly by inserting special Stars (Packetize star, IntToBits Star, etc.).

3.6.2 Scheduler Coordination Across the EventHorizon

Viewed from the EventHorizon, every Wormhole contains a Target which in turn contains a Scheduler, and every Scheduler has a set of polymorphic methods for the purposes of execution of the domain and the coordination of Schedulers on both sides of an EventHorizon. Some of these methods are illustrated in Figure 12. For purposes of executing a domain, the `setup()` method does whatever is appropriate before execution of Blocks in the domain, for example the static scheduling of Blocks in the SDF domain based on the interconnection topology and relative sampling rates. The `run()` method then executes the Blocks by calling their `run()` methods in turn.

For purposes of coordinating two or more Schedulers, each Ptolemy Scheduler has an additional concept of a `StopTime`. That is, `run()` is allowed to execute the Blocks in the domain only up to the `StopTime`. One method of a Scheduler, `setStopTime()`, allows the `StopTime` to be set externally.

Using these methods, multiple Schedulers can be made to behave logically as a single Scheduler. Coordination of multiple DE Schedulers has been addressed in the area of distributed simulation of discrete event systems, for example in *conservative scheduling* [25][28], but may introduce artificial deadlocks because a notion of global time is not available to all processors. In Ptolemy, Schedulers are hierarchically nested, making it easy to maintain a global time. Multiple Schedulers behave logically as a single Scheduler and there is no artificial deadlock. To see how this is achieved, assume for the moment that both the inside and outside Schedulers are (possibly

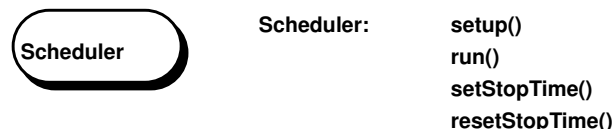

Figure 12. An illustration of some of the polymorphic messages of type Scheduler that support the coordination of two Schedulers.

different) DE Schedulers. The basic structure of a DE Scheduler is shown in Figure 13. It incorporates the concept of a CurrentTime, and is parameterized by a StopTime, which is the maximum allowed value of CurrentTime before execution is suspended. The EventQueue stores the un-processed events, each corresponding to an action (typically arrival of a particular Particle at a particular PortHole of a particular Block) with a TimeStamp specifying the time of that action. The EventQueue sorts the set of events by TimeStamp. In this and subsequent figures we assume that the earliest event is on the left and the latest event is on the right.

The coordination of Schedulers across the EventHorizon is illustrated in Figure 14. Suppose the oldest (earliest) event in the EventQueue of the outer domain is an event at a Wormhole EventHorizon. The outer-domain Scheduler calls the go() method of the WormHole (it treats it like an ordinary star). The WormHole obtains the CurrentTime of the outer domain (which is available to any Star) and sets the StopTime of its Scheduler to equal that time. It then invokes the run() method of its Target, which in turn invokes the run() method of its Scheduler. By setting the inner StopTime equal to the outer CurrentTime, the WormHole ensures that the inner domain cannot get ahead of the outer domain in time. The CurrentTime of the outer domain can safely get ahead of the CurrentTime of the inner domain, because the outer domain supplies all events to the inner domain.

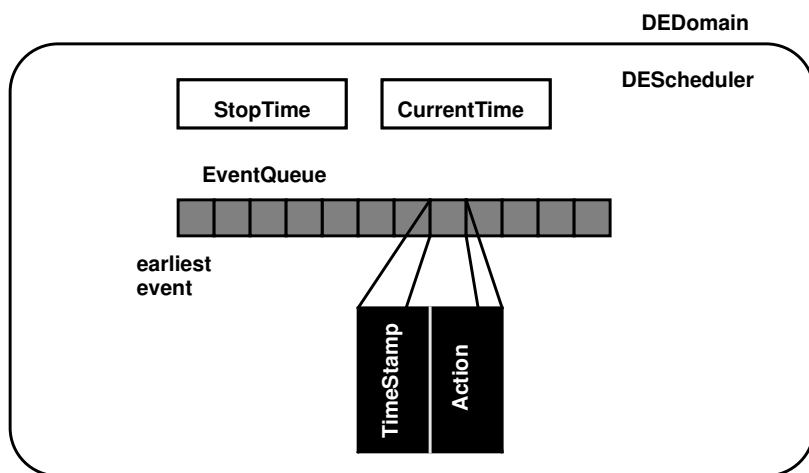

Figure 13. A discrete-event style of Scheduler keeps a sorted EventQueue and is parameterized by a StopTime.

Typically, the inner-domain Scheduler suspends execution at the StopTime, leaving unprocessed the next event on its EventQueue. To ensure that it has an opportunity to execute that event at the proper time, before it returns control to the outer-domain Scheduler, the inner-domain adds an event to the outer-domain EventQueue. Again, this is an action available to any Star. This “self-scheduling event” asks the outer domain to invoke the go() method of the Wormhole at the specified future time, and is the critical feature distinguishing Ptolemy from conservative scheduling.

The above interaction works for any pair of DE Schedulers that are based on event queues. Distinct DE Schedulers are of interest in Ptolemy. For one thing, we want to import pre-existing simulation environments to Ptolemy as domains without the need to replace their Schedulers. For another, different specializations of DE scheduling are of interest; for example, those that associate delay with blocks (enabling data dependency) and those that associate delay with arcs (a simpler model appropriate for hardware timing simulation). In addition, many Ptolemy Schedulers are not recognizable as DE, although they are required to present the same interface at the Event-Horizon. Generally we can divide Schedulers into two categories: timed and untimed. Timed Schedulers keep track of time for each action in the domain, either explicitly (as in the DE exam-

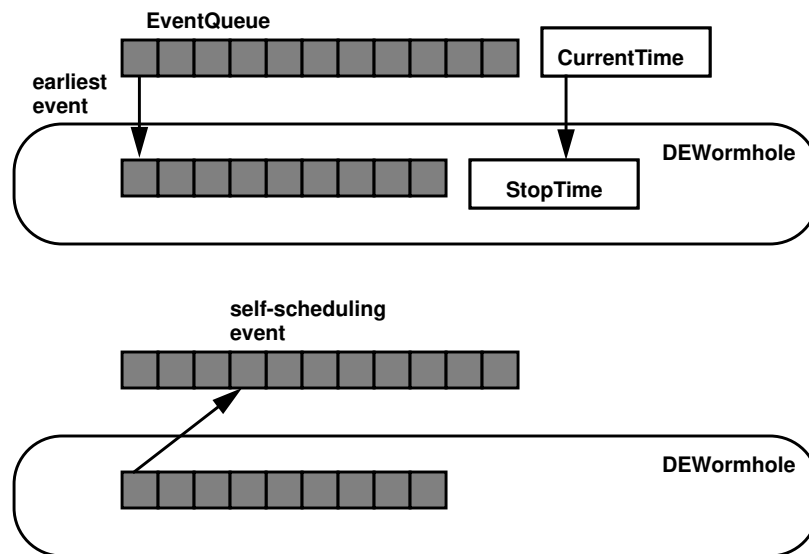

Figure 14. An illustration of conservative scheduling for coordinating two discrete-event Schedulers.

ple) or implicitly (as in the SDF Scheduler, where Particles do not have associated TimeStamps, but nevertheless the Scheduler can associate a time with each new Particle implicitly because it has the sampling rates or equivalent information). Untimed Schedulers do not keep track of time. A Wormhole encapsulating an untimed domain must still model time from an external perspective in case the external domain is timed. However, such a Wormhole is considered to be instantaneous; that is, it executes in zero time by associating the same TimeStamp with each outgoing Particle as the TimeStamp of the most recent input. If this is too coarse a model for any particular subsystem, then a timed-domain model can be substituted.

3.6.3 Inheritance Structure of Blocks

We are now in a position to understand the internal design of Blocks in Ptolemy. A multiple inheritance diagram¹ is shown in Figure 15.

A Block is a base class that includes the data structures of all Blocks, such as a list of States (data structure elements observable from outside a Block) and PortHoles. It also has three key methods invoked by the Scheduler: initialize(), start(), and wrapup(), invoked before executing the Block, at the start of an execution, and at the end of an execution. Runnable is a class that contains a Target, which in turn contains a Scheduler and provides an interface to that Scheduler such as run() and setStopTime().

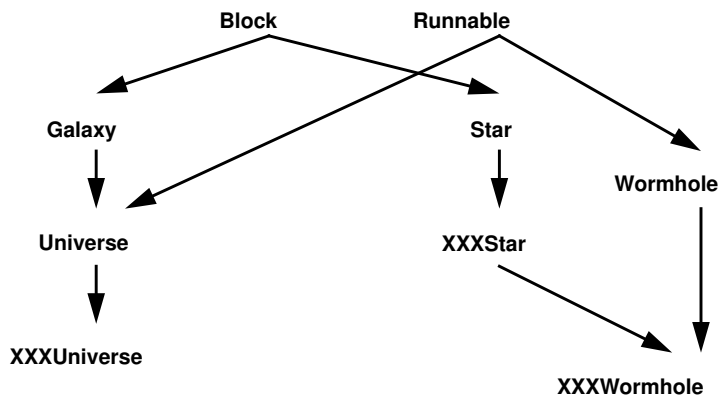

Figure 15. Inheritance diagram for Blocks within domain XXX.

¹ Multiple inheritance simply means that a class assumes the characteristics of two or more base classes.

From these base types, we define the particular types of Blocks. A Galaxy does not include a Scheduler, but simply includes a list of internal Blocks with both internal and external connections to those Block's PortHoles. A Star is a Block that includes the additional method `go()` (execute the internal code). A Universe is a Block that has all the characteristics of a Galaxy (internally composed of interconnected Blocks) but also includes a Target and hence is a Runnable. A Wormhole is simply a Runnable (has an internal Target) that includes an internal Galaxy as well (in this sense it is very similar to a Universe)¹.

For a specific domain XXX, there is an XXXUniverse which is a Universe with a compatible Target that contains an XXXScheduler. An XXXStar is a Star that obeys the particular operational semantics of domain XXX; that is, it obeys specific rules on how it generates and consumes Particles at its PortHoles. Finally, the domain has an XXXWormhole derived from XXXStar. Thus the XXXWormhole provides all the methods of an XXXStar, but internally it has a Galaxy and a Scheduler, unlike XXXStars). Any type of Scheduler and Blocks can be inside the Wormhole. Neither the XXX domain nor the implementation of the XXXWormhole needs to know about the inner domain.

An XXXWormhole is externally indistinguishable from an XXXStar, and hence can be inserted into any XXX domain. How this exploits polymorphism is shown in Figure 16. The Figure shows two methods, `start()`, which is characteristic of all Blocks (including Stars), and `go()`,

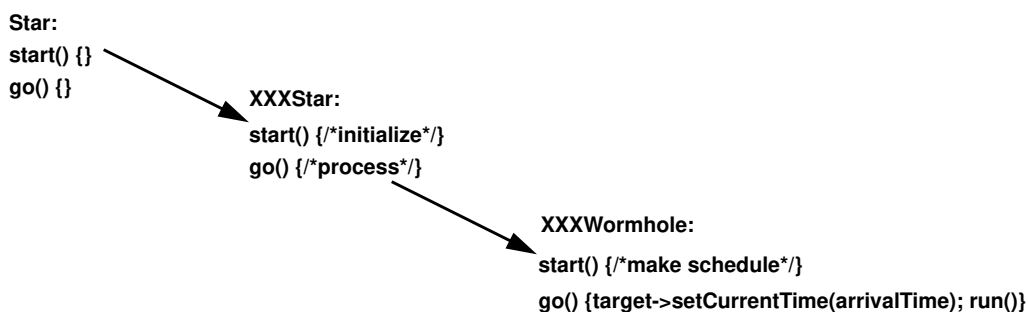

Figure 16. An illustration of how polymorphism allows the XXXStar and XXXWormhole to have the same external interface, even though they are implemented quite differently internally.

1. The XXXWormhole is not derived from Galaxy, but rather contains a Galaxy because it does not have the external interface of a Galaxy while it does have the external interface of an XXXStar.

which is characteristic of all Stars. The method `start()` is called each time a simulation is started or restarted, and in the case of an XXXStar this method typically initializes the internal data structures of the XXXStar (as defined by the programmer of that XXXStar). In the case of an XXX-Wormhole, this method does something quite different; namely, it calls a polymorphic Scheduler method that initializes the schedule. Similarly, the method `go()` executes user-provided code in the case of any XXXStar, but for an XXXWormhole calls the `run()` method provided by any Runnable, which executes the schedule and in turn executes the Stars inside the Wormhole in the proper order (through their respective `go()` methods).

In this manner, polymorphism allows us to achieve extensibility. Any new domain can be added without any modifications to existing domains or to the kernel of Ptolemy itself, and that new domain will be interoperable with the old domains.

3.7 Code Generation

The basic idea of code generation in Ptolemy is simple. The `go()` method of a code generation Star adds ASCII text to a data structure in the Target. The Scheduler, therefore, controls the sequence of generated code. The Target collects the code and supervises the compilation and execution, if any. Any generic optimization capabilities can be put into the base class of the Target or the code generation stars.

While a domain is specific to the computational model used, for code synthesis it is also specific to the type of language generated. Hence, a C code generation domain following SDF semantics is different from an assembly code generation domain following SDF semantics. This is because the libraries of Stars and Targets for the two are quite distinct. The Target is specific to the hardware that will run the code. A given language, particularly a generic language such as C, may run on many targets; code generation functions are therefore cleanly divided between the Domain and the Target.

4.0 Practical Details

Ptolemy has been coded in C++, and successfully compiled using both commercial (Cfront-based) and freely re-distributable (GNU) compilers. The development used Sun-3 and Sun-4 (Sparc) platforms, and Ptolemy has been ported to the DECstation. Efforts are underway to port it to an HP platform as well. The documentation for Ptolemy is extensive [1].

4.1 The Graphical User Interface

The Ptolemy interactive graphical interface (pigi) is a design editor based on tools from the Berkeley CAD framework: the Oct database and the Vem graphical editor [12]. Using pigi, Ptolemy applications are constructed graphically, by interconnecting icons. A special Ptolemy class, *InterpGalaxy* (a derived type of *Galaxy*), is used to dynamically construct simulations based on commands from the graphical interface. Incremental linking is supported, permitting additional stars to be defined, linked into the running pigi executable, and instantiated in the simulation.

The graphical interface runs as two processes: one process is the Vem graphic editor; the second, called *pigiRpc*, contains the Ptolemy kernel and the portion of the graphical interface that knows about Ptolemy. The Unix RPC protocol is used for communication between the two processes.

The graphical interface is by no means integral to Ptolemy. Indeed, we do not believe that any single, homogeneous graphical interface will manage all Domains. Two separate textual interfaces, one with a Lisp-like syntax, and a second based on an embedded interpreter, Tcl [26], have been developed. As with the graphical interface, the text-based interfaces also communicate with the *InterpGalaxy* class to build and run simulations.

4.2 States

Ptolemy provides a *State* class, together with type-specific subclasses (*IntState*, *FloatState*, *StringState*, *IntArrayState*, etc.) for use as parameters, observable variables, and as memory for

code generation applications. Because State objects are visible from the user interface, they can be used to monitor and control the simulation, or to collect statistics.

Every State type has an initial-value string, which may be an expression that refers to other states defined at higher levels (initializers for states in a star may refer to states in the parent galaxy). Initial values of states are referred to as parameters by the user interface. The hierarchical nature of states, and the fairly general expressions permitted, make it easy to define parameterizable Galaxy objects.

4.3 Star Preprocessor Language

The Ptolemy preprocessor (a “schema compiler”) has been developed to make it easier to write and document Star and Galaxy class definitions for use with Ptolemy. Instead of writing all the initialization code required for a Ptolemy star (which contains quite a bit of “standard boilerplate”), the user can concentrate on writing the action code for a star and let the preprocessor generate the standard initialization code for PortHoles, States, etc. The preprocessor also generates documentation in a standard format for inclusion in the manual.

5.0 Some Representative Applications

Several applications of Ptolemy that have been pursued will now be described. One purpose of this will be to illustrate how the heterogenous aspect of Ptolemy manifests itself to the user, and another purpose will be to illustrate how the use of OOP at the user-modeling level can result in much more flexible models.

5.1 Broadband Networking

In the introduction, the use of Ptolemy for simulation of a broadband packet network with associated signal processing is mentioned. Here we give a bit more detail. A block diagram of such a simulation is shown in Figure 17. At the top (Universe) level, the cell-relay network connects a set of terminals. The DE domain is used to model only non-empty cells travelling between terminal and network, each cell marked with a TimeStamp. Internally the terminals have a com-

plicated structure (control, signal processing for video compression, etc.), but let us concentrate on the network. Internally it consists of a signalling entity (programmed in the MQ domain) and a set of interconnected ATM switches. The internal simulation of each ATM switch is in the SDF domain (so that all cells are modelled, including empty cells) because the most convenient model is as a synchronous digital machine (especially if we anticipate moving down to logic and timing hardware-modeling levels). Within the switch there is another call-processing entity (in the MQ domain) for control of this switch, and a shuffle-exchange type of interconnected 2x2 switches. Finally, those switches consist of a 2x2 switching matrix plus associated routing tables.

Most interesting is the interconnection of foreign domains. Internal to Ptolemy this is handled by the Wormhole, but it is also an issue at the level of user modeling. For example, cells that arrive from the DE domain at a switch must be augmented with empty cells internal to the switch

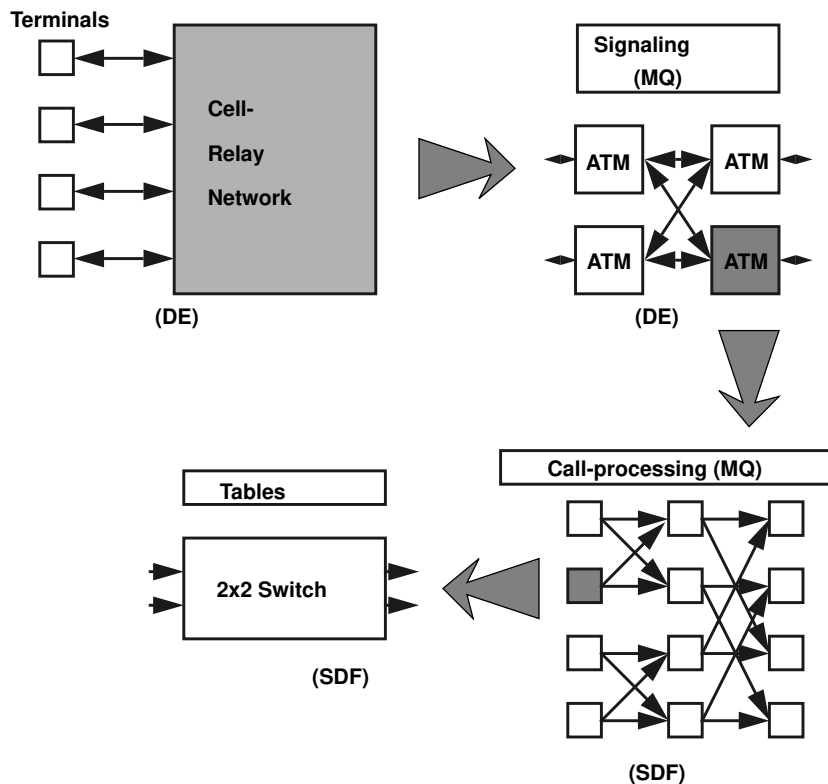

Figure 17. An ATM cell-relay simulation in Ptolemy, illustrating the hierarchical description and mixture of domains. In each case the shaded block is shown in internal detail.

to fill out an isochronous (constant rate) stream of cells, because the switch is modeled in the SDF domain. This requires a cell interpolator driven by an isochronous clock at the interfaces to the switch within the DE domain, so that cells passing the EventHorizon into the SDF domain have uniformly spaced TimeStamps. Similarly, the communication between the call-processing in the MQ domain within the switch and the routing tables within the switch in the SDF domain requires an interpolator. In this case the MQ domain is untimed, and operates instantaneously from a timed domain's perspective. When a message arrives from the network-level call processing, it passes through the DE domain and therefore has appended TimeStamps. The switch-level call processing then generates messages in response to update the routing tables, and these messages have the same TimeStamp (since the MQ domain is untimed, the call-processing operates instantaneously). Before these messages can be sent, however, they must be interpolated to an isochronous message stream, because the routing tables are in the SDF domain.

This example illustrates that Ptolemy does not automatically solve all problems related to interconnecting domains; rather, there is often work to be done at the user modeling level. Often, however, this work is not an artifact of the modeling technique, but is a functional requirement in the system being simulated. For example, the interpolation of messages from the call processing arriving at the routing tables, a synchronous digital system, is a functional requirement of the system being modeled.

5.2 Signal Processing

A wide variety of signal processing applications have been developed using Ptolemy, including several adaptive filtering applications, power spectrum estimation, several parametric and waveform coding techniques based on linear prediction, communication channel modeling, digital communication receivers, beamforming, digital filter design, chaos simulations, phase-locked loops, image coding, and music synthesis. Many of these applications are distributed with the Ptolemy code as demonstrations.

Most signal processing *algorithms* are conveniently defined within the synchronous data-flow model of computation. Hence, for algorithm development and simulation, there is little need for heterogeneity. However, turning an algorithm into a product involves both real-time prototyp-

ing and real-time control. For the former, we have been concentrating on synthesis of code for parallel programmable DSP processors.

Ptolemy is capable of automatically partitioning, scheduling, and generating DSP assembly language for a multi-processor DSP system [29][30]. Currently, it is required that the problem fit the synchronous dataflow model; a future version will exploit heterogeneity to remove that restriction by mixing Schedulers that operate at code-generation time with Schedulers that synthesize run-time code [9]. For real-time control, using the Wormhole concept, part of an application can be run on a DSP board while the remainder of an application is executed on a host microprocessor.

At present, Ptolemy can generate C code, Motorola 56000 and 96000 assembly code, and assembly code for the Sproc multiprocessor DSP from Star Semiconductor. Code generation for other processors is planned.

5.3 Hardware-Software Co-design

Most electronic systems mix custom circuit designs with programmable commodity parts. Ptolemy supports such designs as a unit, since using the various domains described above, all parts of the system can be modeled. For example, the Thor domain can be combined with a code generation domain to design boards that mix custom hardware with programmable DSPs. Since the hardware and software are both modeled within the same software framework, a designer can easily explore tradeoffs between hardware and software implementations of various functions.

An example of such a design is shown in Figure 18 [15]. The top window shows the top level of an algorithm that simulates the impairments of a telephone channel. This algorithm is fairly complicated, including linear and non-linear distortion, frequency offset, phase jitter, and additive Gaussian noise. The design is built in a code generation domain compatible with the SDF model of computation. The bottom window shows a hardware design in the Thor domain containing two programmable DSPs communicating through a dual ported shared memory. This hardware might be used to implement the telephone channel simulator for production-line testing of voiceband data modems.

Some Representative Applications

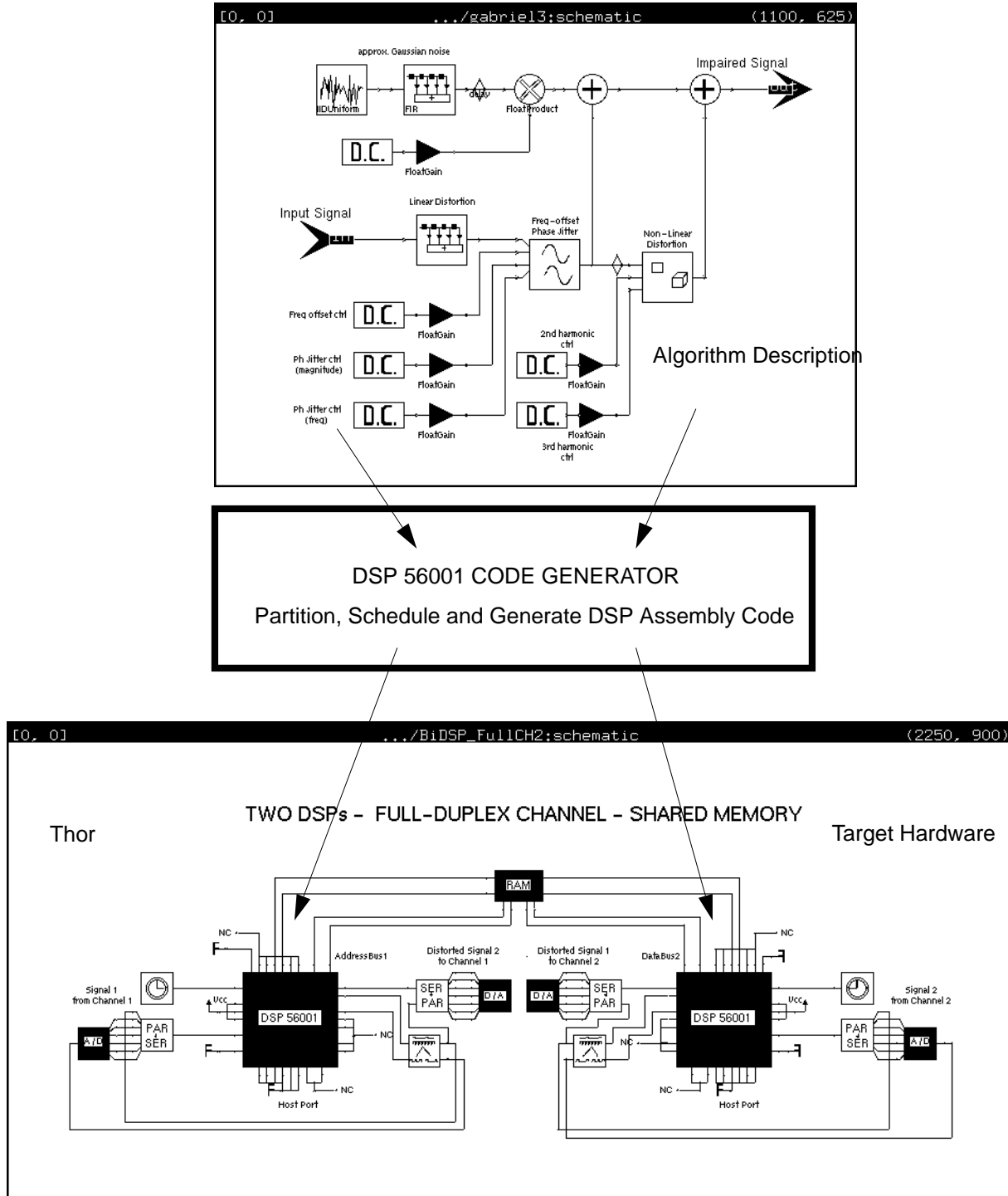

Figure 18. A hardware design (bottom) containing programmable DSPs can be developed together with the software (top) that will run on the DSPs. This Figure shows the top level only of a telephone channel simulation algorithm (top window) being mapped onto a board design with two Motorola DSP56001 DSPs.

The design shown in Figure 18 is one of many that could accomplish the stated objectives. Using Ptolemy, the entire design, ranging from algorithm development to circuit design, can be carried out within a unified environment. This enables exploration of many design alternatives before resources are committed to hardware prototyping.

The hardware-software co-design problem is becoming increasingly important in large (and even small) system design. One of the key advantages of Ptolemy is the ability to freely mix behavioral, hardware, and software entities, modeling each in a natural way. In fact, in many instances the actual production software can be developed in an appropriate Ptolemy domain, and functionally tested in combination with its associated hardware subsystems.

5.4 Source and Link Modeling

A final example will illustrate the value of OOP abstractions in obtaining flexible models in Ptolemy, using the simple example of the modeling of sources and links in the communications network. Consider the simple situation modeled in Figure 19. We would like to be able to freely intermix source and link models, regardless of the nature of the source or link. For example, the source could generate data packets or speech samples or video frames, and the link could consist of a simple bit-error model or a full physical-layer simulation. Using polymorphism in the Particle can achieve this goal by defining in the Particle class methods `convertToBits()` and `convertFromBits()` which generate a bit-string representation of any Particle. The link model then accepts Particles, and employs `convertToBits()` to generate a bit string, apply the link model to that bit string, and use Particle `convertFromBits()` to convert back to Particles at the output. There are a number of issues in actually implementing this, but this oversimplification does illustrate the value of OOP at the user-modeling level.

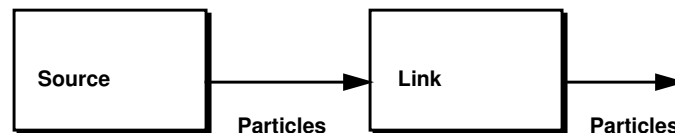

Figure 19. A simple network modeling problem.

6.0 CONCLUSIONS

Ptolemy has been used internally in Berkeley for approximately two years for a growing number of simulation efforts, such as signal processing, electric power network simulation, and wireless and broadband network simulation. It has also been used successfully for instructional purposes in one graduate and one undergraduate course. It has been distributed externally for about one year, and is now used in a growing community of academic and industrial organizations. Aside from the usual problems of installation and environment compatibility, these efforts can generally be characterized as very successful. The ability of Ptolemy to simulate, and to a lesser extent rapidly prototype heterogeneous systems has been demonstrated by a number of applications.

In terms of useful user models (Stars and Galaxies), the most fully-developed domain is SDF, with many models for signal processing and data communications. Currently a similar set of models is being developed in the DE domain for networking (packet, multiple access, and wireless) simulations. New domains are also under development. For example, a high-level circuit synthesis domain based on synthesis work at Berkeley is planned.

There are also recognized deficiencies in the kernel of Ptolemy, and enhancements are planned. One deficiency is the relatively simplistic manner in which a simulation is controlled from the GUI at runtime. Another deficiency is the GUI itself, which unlike the remainder of Ptolemy is not object-oriented. An OOP GUI design would encapsulate the interface to each domain within that domain itself, allowing graphical interfaces to be customized for a domain.

Some of the extended capabilities of Ptolemy can be achieved in other ways, and it is useful to compare them. For example, the generality of Ptolemy could be achieved by a single discrete-event domain, which is itself completely general as a modelling tool. There are two disadvantages:

- The discrete-event modeling of certain subsystems is unnatural, and will likely be resisted by designers. Examples include multirate signal processing (where associating a time stamp with

each sample is unnecessary and awkward) and control software domains (where not only is it unnatural, but could not be considered for production software).

- Discrete-event modeling is significantly less efficient at runtime for some subsystems (the aforementioned included). This needs, however, to be balanced by the additional overhead of EventHorizon conversion in Ptolemy.

CAD frameworks allow design databases to be transferred from one tool to another. Unlike Ptolemy they are focused on applying different toolkits (simulation, routing, logic minimization, etc.) to a common design. Such frameworks do not address the heterogeneous subsystem problem directly (for example do not address control software). Further, frameworks typically work through interprocess communication or file formats, whereas Ptolemy performs the simulation in a common virtual address space (advantageous for efficiency in large simulations). With respect to CAD frameworks, Ptolemy can be considered to be one tool.

The appropriate use of Ptolemy is as a basic framework for simulations (as well as prototyping tools). It can be used is a diversity of design groups focused on different aspects of a large system design, where each group can tailor a domain or small set of domains to their need and liking. The major advantage is that the efforts of the different groups can readily be merged for the purpose of checking interoperability. Also, different details of modeling can be used for each subsystem (another form of heterogeneity): a high level (and rapidly executing) model for routine use in simulation of other subsystems, down to a very detailed model of every subsystem (and very slow execution) for final verification of the design. This is typically not done today.

With the increasing complexity of systems, the goal should be a design that is “right from the start”. Ptolemy is a tool that can support that rigorous design style.

7.0 ACKNOWLEDGEMENTS

While this paper emphasizes the internal design of the Ptolemy kernel, a number of our colleagues have contributed to Ptolemy and to the modeling in Ptolemy. The broader Ptolemy project currently includes more than twenty students and three full-time-equivalent staff mem-

bers. Many of these people have made significant contributions to the ideas described in this paper. Ichiro Kuroda contributed extensively to the early design of the State processor and interpreter. Edwin Goei is the principle architect of the GUI, with Wan-Teh Chang contributing some refinements. The OCT/VEM group at Berkeley has been most cooperative in responding to our requests for enhancements to that system.

The applications mentioned here have been pursued by other colleagues. Alan Lao, Wan-Teh Chang, John Loh, and Philip Bitar have worked on networking models. Asawaree Kalavade is working on hardware/software co-design and Tom Parks is working on embedded microcontrollers. Jose Pino is working on assembly code generation. A number of other colleagues are working on other applications.

The Ptolemy project has been supported by the Defense Advanced Projects Research Agency, the Semiconductor Research Corporation through its Berkeley Center of Excellence in CAD/IC (Grant 92-DC-008), the National Science Foundation, the State of California MICRO program, Bell Northern Research, Comdisco Systems, Dolby Labs, Hitachi, Hughes Network Systems, Motorola, NEC, Philips, Rockwell, Sony, Star Semiconductor, and US West.

8.0 REFERENCES

- [1] *The Almagest: Manual for Ptolemy Version 0.3.1*, Department of EECS, University of California, Berkeley, CA 94720, USA, January, 1992.
- [2] J. Bier, E. Goei, W. Ho, P. Lapsley, M. O'Reilly, G. Sih and E.A. Lee, "Gabriel: A Design Environment for DSP," *IEEE Micro Magazine*, October 1990, Vol. 10, No. 5, pp. 28-45.
- [3] J. Buck, S. Ha, E. A. Lee, and D. G. Messerschmitt, "Multirate Signal Processing in Ptolemy", *Proc. of the Int. Conf. on Acoustics, Speech, and Signal Processing*, Toronto, Canada, April, 1991.
- [4] J. Buck and E. A. Lee, "The Token Flow Model," presented at *Data Flow Workshop*, Hamilton Island, Australia, May, 1992.
- [5] N. Carriero and D. Gelernter, "Linda in Context," *Comm. of the ACM*, Vol. 32, No. 4, pp. 444-458, April 1989.
- [6] A. L. Davis and R. M. Keller, "Data Flow Program Graphs," *IEEE Computer*, Vol 15, No. 2, February 1982.
- [7] J. B. Dennis, "Data Flow Supercomputers," *IEEE Computer*, Vol 13, No. 11, November, 1980.
- [8] L. James Faber, "Capsim", ECE Dept. North Carolina State University, Raleigh, NC 27695
- [9] Soonhoi Ha and E.A. Lee, "Compile-Time Scheduling and Assignment of Dataflow Program Graphs with Data-Dependent Iteration," *IEEE Transactions on Computers*, November, 1991.

REFERENCES

- [10] D. Harel, "Statecharts: A Visual Formalism for Complex Systems," *Sci. Comput. Program.*, vol 8, pp. 231-274, 1987.
- [11] D. Harel, H. Lachover, A. Naamad, A. Pnueli, M. Politi, R. Sherman, A. Shtull-Trauring, M. Trakhtenbrot, "STATEMATE: A Working Environment for the Development of Complex Reactive Systems," *IEEE Tr: on Software Engineering*, Vol. 16, No. 4, April 1990.
- [12] D. S. Harrison, P. Moore, R. Spickelmier, A. R. Newton, "Data Management and Graphics Editing in the Berkeley Design Environment," *Proc. of the IEEE Int. Conf. on Computer-Aided Design*, November 1986.
- [13] *IEEE Standard VHDL Language Reference Manual*, IEEE STD 1076-1987, The IEEE, Inc., 345 East 47th St., New York, NY, USA, 1987.
- [14] R. Jagannathan and A.A. Faustini, "The GLU Programming Language," Technical Report SRI-CSL-90-11, Computer Science Laboratory, SRI International, Menlo Park, California 94025, USA, November, 1990.
- [15] A. Kalavade, "Hardware/Software Co-design Using Ptolemy", MS Report, Electronics Research Laboratory, University of California, Berkeley, CA 94720, December, 1991.
- [16] S. Y. Kung, *VLSI Array Processors*, Prentice-Hall, Englewood Cliffs, New Jersey, 1988.
- [17] E. A. Lee and D. G. Messerschmitt, "Static Scheduling of Synchronous Data Flow Programs for Digital Signal Processing" *IEEE Transactions on Computers*, January, 1987.
- [18] E. A. Lee and D. G. Messerschmitt, "Synchronous Data Flow" *IEEE Proceedings*, September, 1987.
- [19] E. A. Lee, W.-H. Ho, E. Goei, J. Bier, and S. Bhattacharyya, "Gabriel: A Design Environment for DSP", *IEEE Trans. on ASSP*, November, 1989.
- [20] E. A. Lee and J. C. Bier, "Architectures for Statically Scheduled Dataflow", reprinted in *Parallel Algorithms and Architectures for DSP Applications*, ed. M. A. Bayoumi, Kluwer Academic Pub., 1991.
- [21] E. A. Lee, "Consistency in Dataflow Graphs", *IEEE Transactions on Parallel and Distributed Systems*, Vol. 2, No. 2, April 1991.
- [22] E. A. Lee, "A Design Lab for Statistical Signal Processing," *Proceedings of ICASSP*, San Francisco, March, 1992.
- [23] D. G. Messerschmitt, "A Tool for Structured Functional Simulation," *IEEE J. on Selected Areas in Communications*, Vol. SAC-2, No. 1, January 1984.
- [24] D. G. Messerschmitt, "Structured Interconnection of Signal Processing Programs," *Proc. of Globecom*, Atlanta, Georgia, 1984.
- [25] J. Misra, "Distributed Discrete-Event Simulation", *Computing Surveys*, Vol. 18, No. 1, Nov. 1985.
- [26] J. K. Ousterhout, "Tcl: An Embeddable Command Language", 1990 Winter USENIX Proceedings, 1990.
- [27] J. L. Peterson, *Petri Net Theory and the Modeling of Systems*, Prentice-Hall, Englewood Cliffs, New Jersey, 1981.
- [28] R. Righter, J. C. Walrand, "Distributed Simulation of Discrete Event Systems," *IEEE Proceedings*, Vol. 77, No. 1, pp. 99-113, January 1989.
- [29] G.C. Sih, E.A. Lee, "A Compile-Time Scheduling Heuristic for Interconnection-Constrained Heterogeneous Processor Architectures", to appear, *IEEE Trans. on Parallel and Distributed Systems*, 1992.
- [30] G. C. Sih and E. A. Lee, "Declustering: A New Multiprocessor Scheduling Technique," to appear in *IEEE Trans. on Parallel and Distributed Systems*, 1992.

REFERENCES

- [31] P. D. Stotts, "The PFG Language: Visual Programming for Concurrent Computing," *Proc. Int. Conf. on Parallel Programming*, Vol. 2, pp. 72-79, 1988.
- [32] *Thor Tutorial*, VLSI/CAD Group, Stanford University, 1986.
- [33] G. S. Whitcomb and A. R. Newton, "Data-Flow/Event Graphs," Memorandum No. UCB/ERL M92/24, Electronics Research Lab, University of California, Berkeley, CA 94720, USA, March 4, 1992.